

Vector Frame Curved Banner CR-03

VF-CR-03

Vector Frame™ curved banners combine 50mm aluminum extrusion frames with push-fit fabric graphics to create a versatile single and double-sided banner, backwall or interior display. Use as a concave or convex shape.

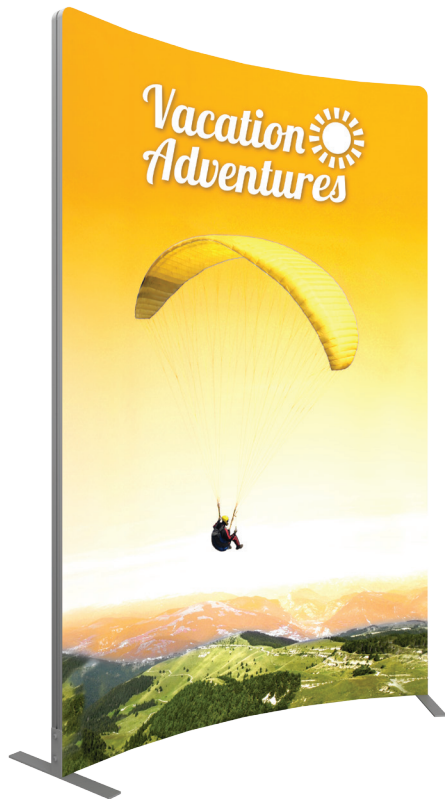

features and benefits:

- 50mm silver extrusion frame
- Single or double-sided SEG push-fit fabric graphics
- Use as either concave or convex shape
- Comes packaged in one OCL wheeled molded case for transport or storage
- Lifetime hardware warranty against manufacturer defects

dimensions:

Hardware

Assembled unit:
67.99" w x 94.74" h x 18.75" d
1726.946mm(w) x 2406.396mm(h) x 476.25mm(d)

Shipping

Shipping dimensions - ships in 1 case:
One OCL case: 57" l x 19" h x 19" d
1449mm(l) x 483mm(h) x 483mm(d)

Approximate shipping weight (entire kit):
53.26 lbs / 24.16 kgs

Graphic

Total visual area:
Concave: 61.05" w x 94.375" h
1551mm(w) x 2397mm(h)

Convex: 62.62" w x 94.375" h
1591mm(w) x 2397mm(h)

Please be sure to include a 2" bleed around the perimeter

Refer to related graphic templates for more information

Visit: www.exhibitors-handbook.com/graphic-templates

additional information:

Graphic material:
Dye-sublimated fabric

For single-sided units: specify convex or concave; no blank back is offered

Optional lighting available

We are continually improving and modifying our product range and reserve the right to vary the specifications without prior notice. All dimensions and weights quoted are approximate and we accept no responsibility for variance. E&OE. See Graphic Templates for graphic bleed specifications.

Parts Included:

Code	Qty	Description
F34	x4	1155MM (45.47") PHFC2 EXTRUSION WITH IB2 HOLE ONE SIDE - WITH LOCK ONE END
F56	x2	6R X 45 DEGREE PHFC2 EXTRUSION WITH IB2 LOCK HOLES ONE SIDE - CAM LOCK ONE SIDE
VF-CR-03-CV-G	x1	1593MM (62.75")W X 2400MM (94.5")H FABRIC GRAPHIC W/FEC-2 ALL SIDES
VF-CR-03-CC-G	x1	1554MM (61.18")W X 2400MM (94.5")H FABRIC GRAPHIC W/FEC-2 ALL SIDES
CB9-S	x2	50MM SQUARE PHCF2 CORNER BRACKET
CB9-R	x2	50MM ROUND PHCF2 CORNER BRACKET
SW-FOOT	x2	VECTOR FRAME SUPPORT FOOT
IB2	x2	PH INLINE CONNECTOR

VF-CR-03

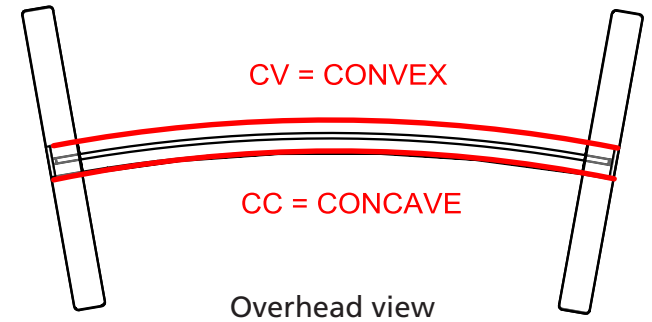
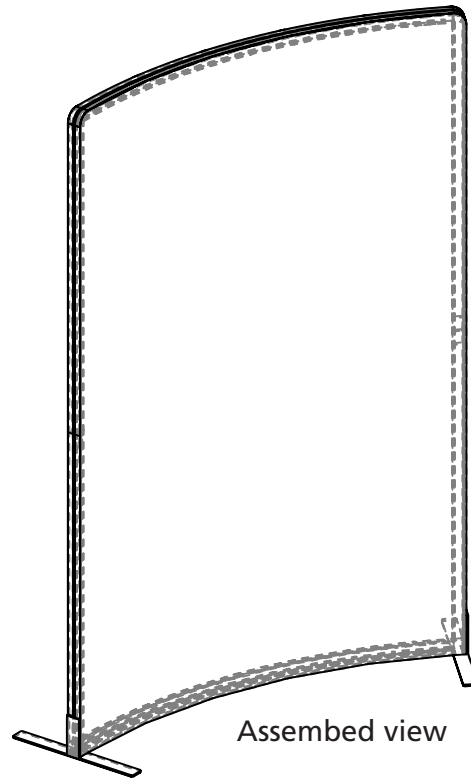
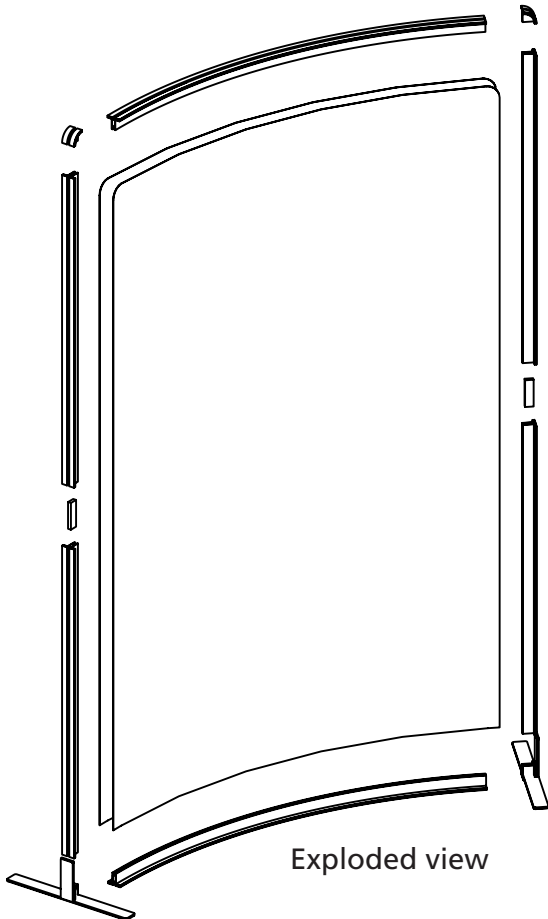

Step 1: Assemble Frame

Arrange pieces on the floor as shown in the diagram below. Assemble frame by securing CB9-R's on the top and CB9-S's on the bottom to the F56 and F34s. When locking be sure to turn each cam a little bit and then go back and tighten to the proper tension. Take care to turn locks only half a turn. Slide the IB2 into the extrusion to connect sides. Tighten to the proper tension to lock extrusions together.

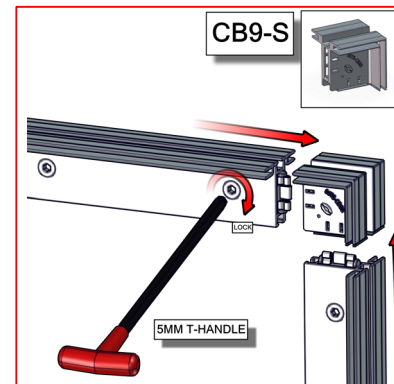
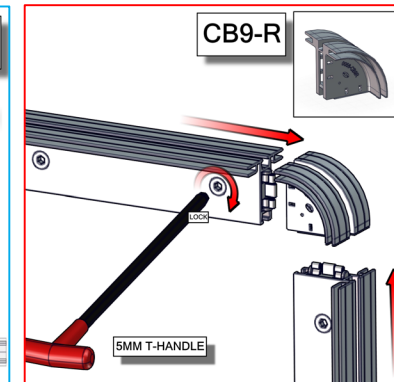
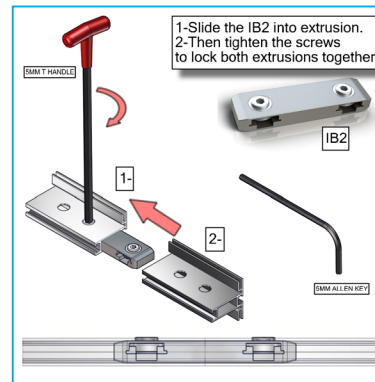
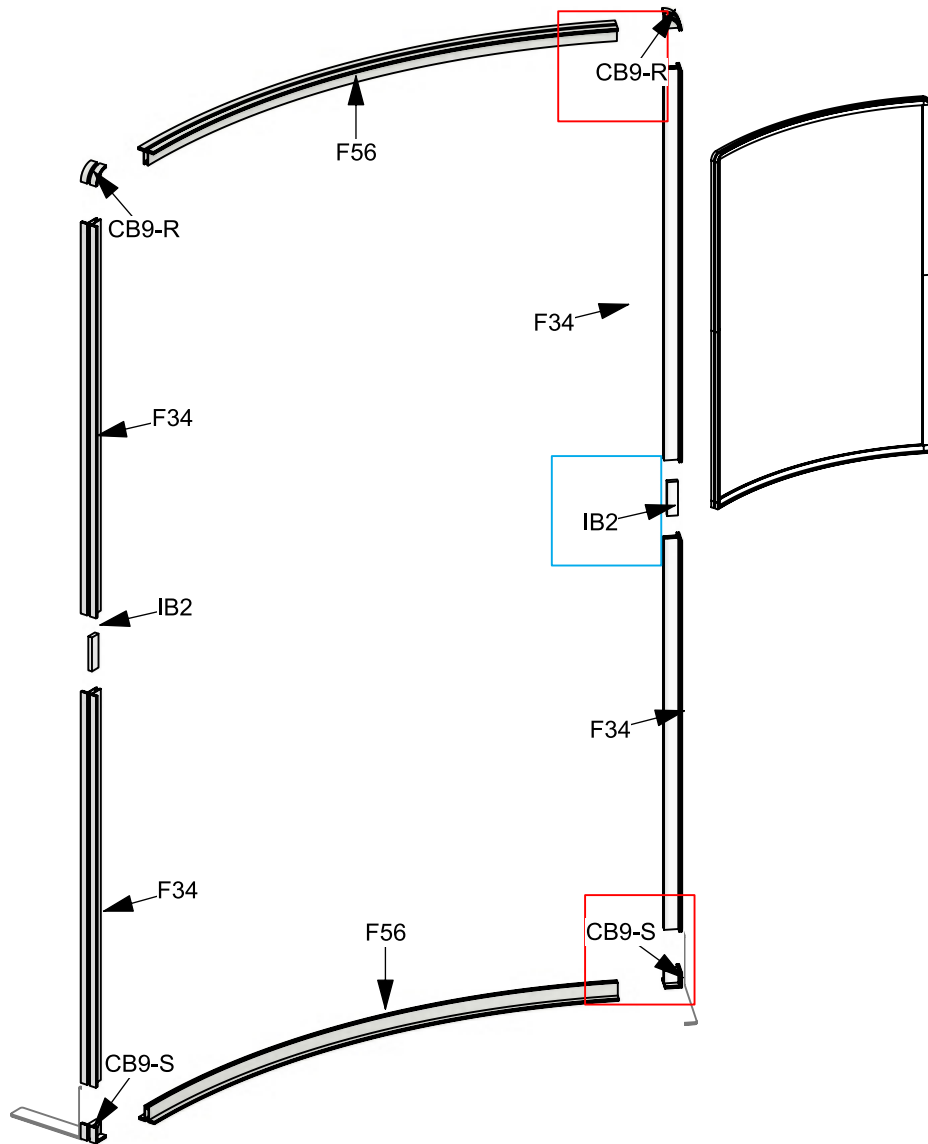

Step 2: Attach feet to frame & apply graphics

To adhere foot to frame, loosen thumbscrews from foot. Slide extrusion into LN-100 groove. Gently tighten the foot into place. Install graphic(s) by pressing the FCE-2 edge of graphic into the channel of the extrusion. Start in upper left corner and then secure the upper right corner. Secure each corner first, then down each side to the bottom. Assure each graphic is tightly inserted. When taking graphics off, take care to gently pull by attached pull tab. Set frame aside.

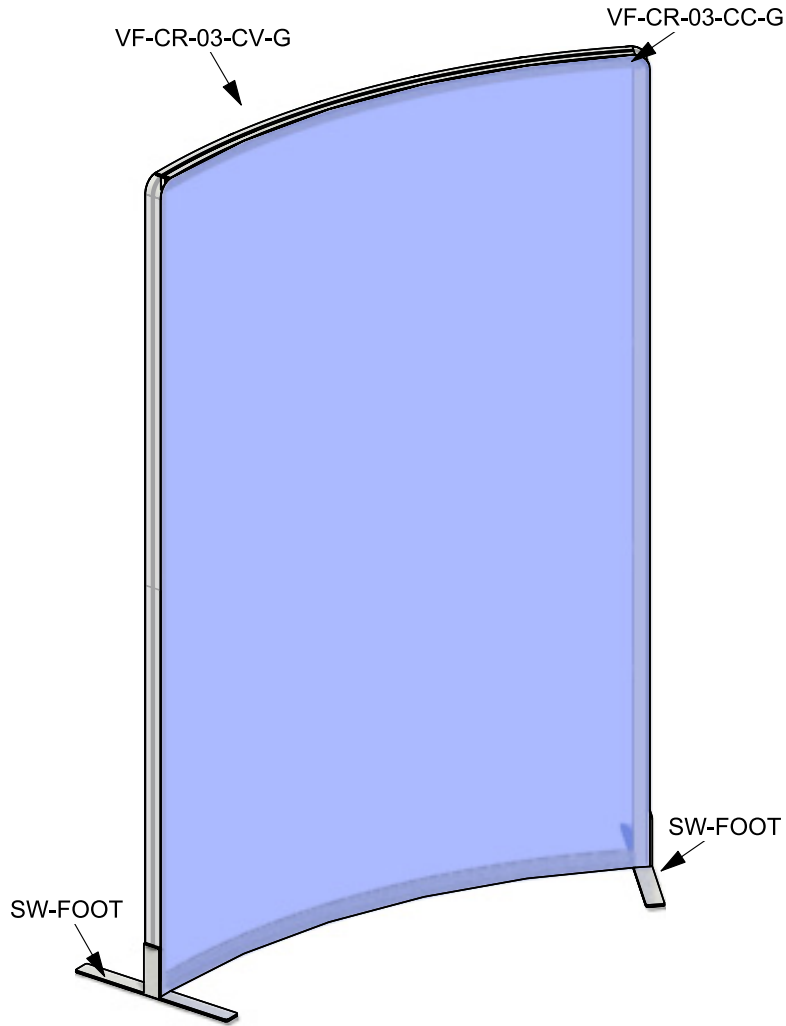

FCE-2 TO PHFC4

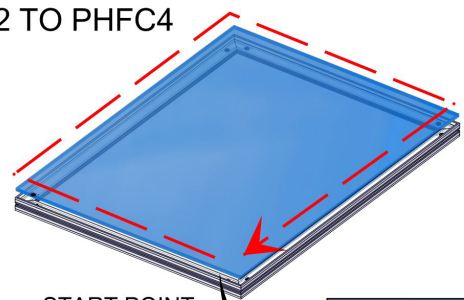

START POINT ONE CORNER

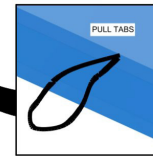

FCE-2 TO PHFC2

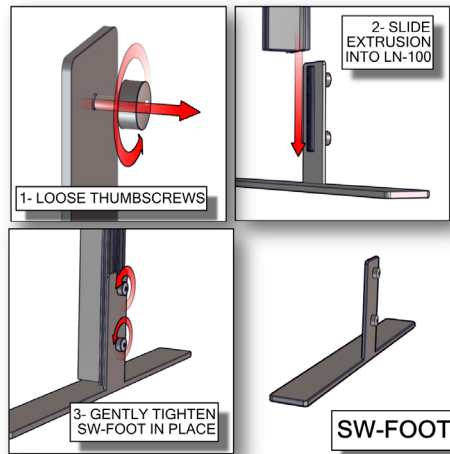
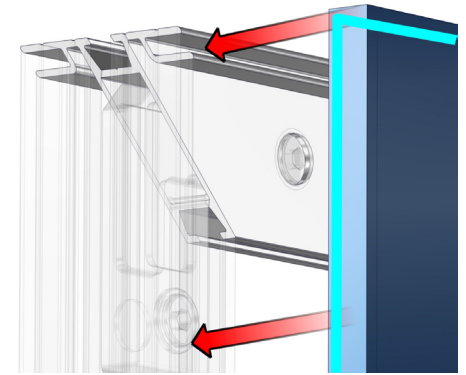

OPTIONAL:

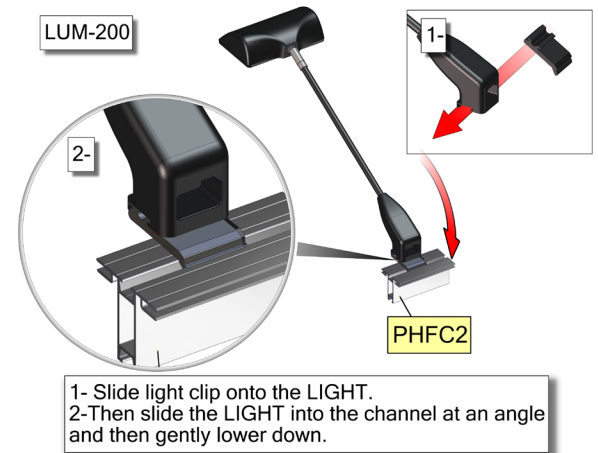

Vector Frame Banners and Light Boxes

Banners:



Vector Frame Banner
VF-R-01

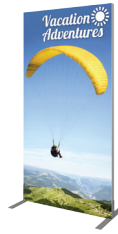

Vector Frame Banner
VF-R-02



Vector Frame Banner
VF-R-03



Vector Frame Banner
VF-R-04



Vector Frame Banner
VF-R-05



Vector Frame Banner
VF-S-01



Vector Frame Banner
VF-S-02



Vector Frame Banner
VF-S-03



Vector Frame Banner
VF-S-04

Lightboxes:



Vector Frame Lightbox
VF-LF-R-01



Vector Frame Lightbox
VF-LB-R-02



Vector Frame Lightbox
VF-LB-R-03



Vector Frame Lightbox
VF-LB-R-04



Vector Frame Lightbox
VF-LB-R-05



Vector Frame Lightbox
VF-LB-S-01



Vector Frame Lightbox
VF-LB-S-02



Vector Frame Lightbox
VF-LB-S-03

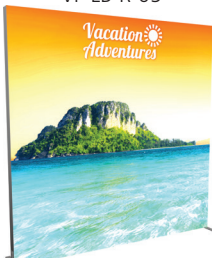

Vector Frame Lightbox
VF-LB-S-04