

# MODCO 4 - 10X10

MODCO MODULAR EXHIBITS

PRODUCT CODE: MODCO4-10x10G



On frame On graphic



FRONT



BACK

## PRODUCT DESCRIPTION

Modco Modular Exhibits Modular 4 is a three-dimensional 20' x 10' pre-designed exhibit booth. Stylish and lively, Modco Modular Exhibits Modular 4 is built using tool-free perforated modular aluminum frames. Multiple size frames connect using simple toolless pin connectors. Use shelves to showcase your products. Customize double-sided stretch fabric SEG graphics for the entire exhibit. Perforations are completely covered for a flawless finish.

DISPLAY DIMENSIONS	234.375"W x 97.9"H x 117.5"D		
GRAPHIC SIZES	PANEL	SIZE	QTY
	A	196.375"W x 96.25"H	1
	B	235.375"W x 96.25"H	1
	C	35.25"W x 94.375"H	1
	D	20.5"W x 96.25"H	2
	E	40.125"W x 96.25"H	2
	F	40.125"W x 109.125"	1
	G	40.125"W x 109.125"	1
	H	39.125"W x 97.75"	2
TOTAL PRINTS			11

## GRAPHIC MATERIAL

Stretch Fabric w/Integrated Block Out

## GRAPHIC FINISHING

Silicone beading is sewn around the perimeter of the fabric graphic. Silicone beading is hidden from view once installed.

## DISPLAY CONSTRUCTION

Aluminum frame and components

## SHIPPING WEIGHTS & DIMENSIONS (FREIGHT ONLY)

Shipping Weight	1107 lbs (frame & graphics in crate)
Shipping Dimensions	103"L x 44"W x 58"H (in crate)

## GRAPHIC TURN AROUND TIME

5 business days after proof approval

AVAILABILITY	CA only
--------------	---------

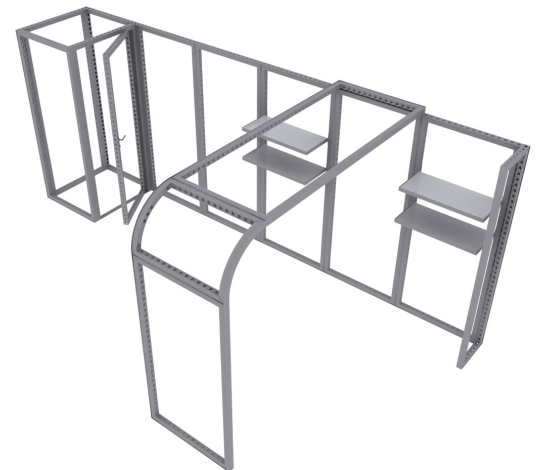
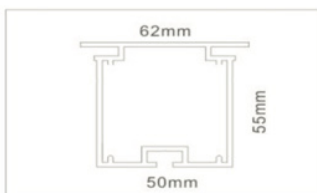
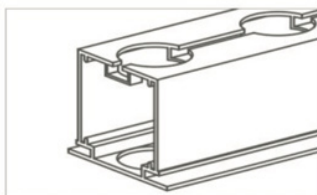

FRAME ONLY

## PARTS LIST

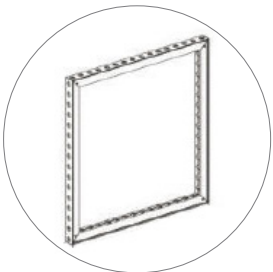

(qty 9)  
MOD-FRM-992x2418

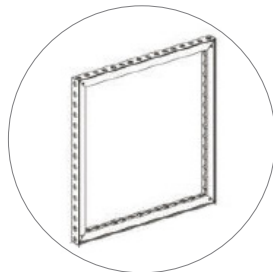

(qty 1)  
MOD-FRM-310x1984

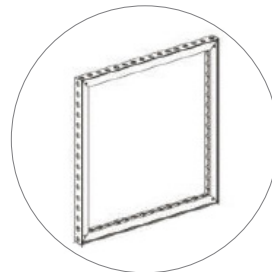

(qty 1)  
MOD-FRM-992x1984

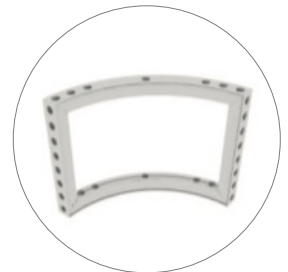

(qty 1)  
MOD-CRVFRM-774x992

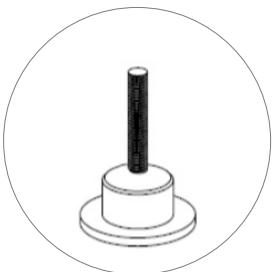

(qty 4)  
MOD-PCWP-B



(qty 1)  
MOD-DSWL-992x2418



(qty 4)  
MOD-SN28mm

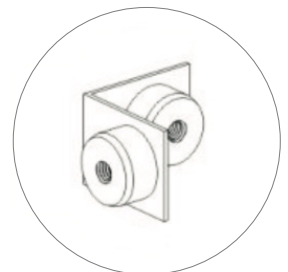

(qty 16)  
MOD-90D-CON

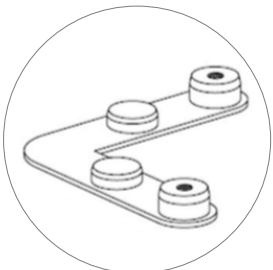

(qty 6)  
MOD-SM90D-CON

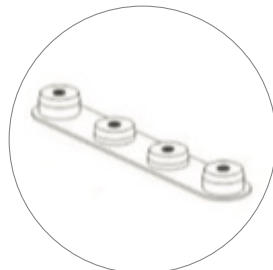

(qty 2)  
MOD-CRV-180DCL

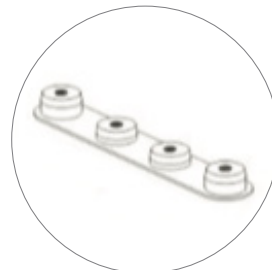

(qty 2)  
MOD-CRV-180DCR

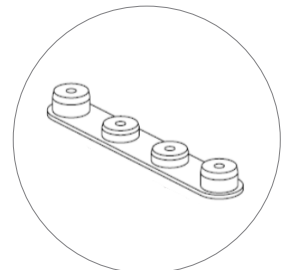

(qty 8)  
MOD-180D-CON



(qty 1)  
MOD-CP-3100

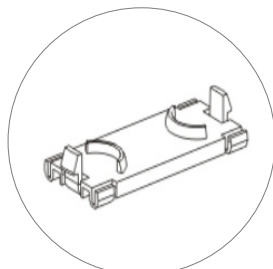

(qty 23)  
MOD-CC

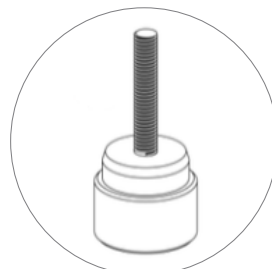

(qty 80)  
MOD-PC



(qty 2)  
MOD-CP-774

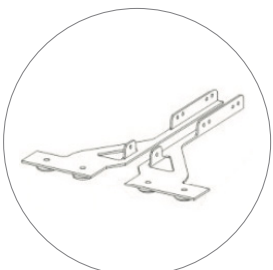

(qty 4)  
MOD-SHELF-KIT-INS

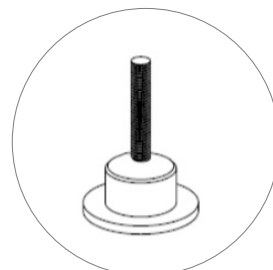

(qty 4)  
MOD-PC-DOOR

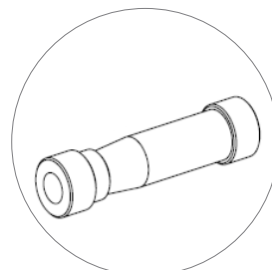

(qty 10)  
MOD-CLA-CON

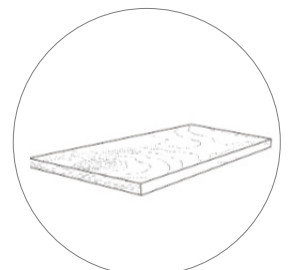

(qty 4)  
MOD-PNL

## SET UP INSTRUCTIONS

### MODCO-4

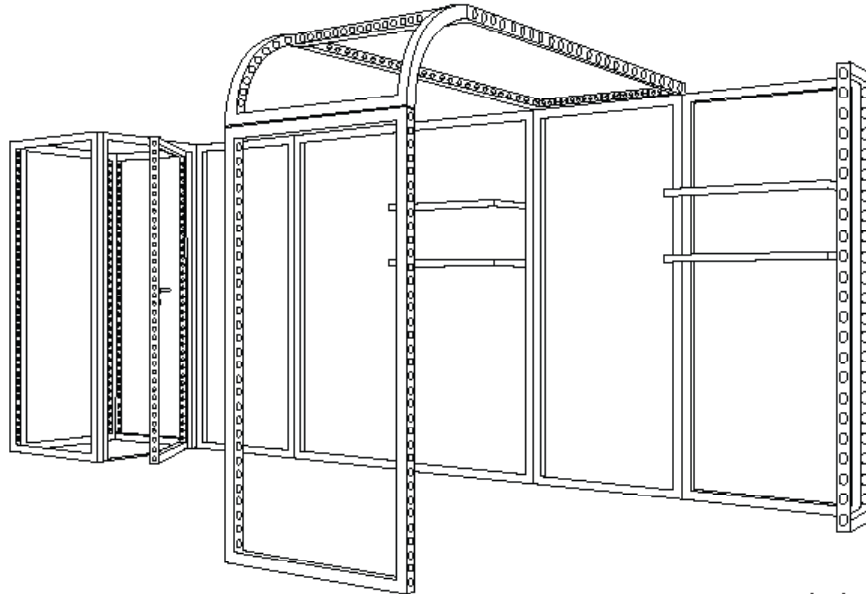

Instructions

### Parts / Frames

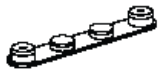

**180° Connector**  
MOD-180D-COM  
Qty:5

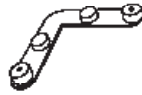

**Small 90° Connector**  
MOD-SM90D-COM  
Qty:5



**Pin Connector**  
MOD-PC  
Qty:64



**Door Pin Connector**  
MOD-PCDOOR  
Qty:4



**Clip Connector**  
MOD-CC  
Qty:21



**180° Curved Connector**  
MOD-CRF-180DCL  
Qty:2  
MOD-CRF-180DCH  
Qty:2



**Clamp Connector**  
MOD-CLA-COM  
Qty:10



**90° Connector**  
MOD-90D-COM  
Qty:15



**1/4 Curved Cover Profile**  
MOD-CP-774  
Qty:2



**1/4" / 3/8" Cover Profile**  
MOD-CP-5100  
Qty:2 - 58" / Qty:2 - 78"



**90° Cover Profile**  
MOD-CP-5100  
Qty:4



**Shelf Kit (parting kit)**  
MOD-SHELF-KIT-INS  
Qty:4 (pair)



**90° Door**  
MOD-DSWL-992x2418  
Qty:1



**992 x 1984 Door Frame**  
MOD-FRM-992x1984  
Qty:1



**992 x 2418 Door Frame**  
MOD-FRM-992x2418  
Qty:3



**992 x 2418 Door Frame**  
MOD-FRM-992x2418  
Qty:1

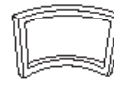

**992 x 992 Door Frame**  
MOD-FRM-774x992  
Qty:1



**Cover Shelf**  
MOD-PVL  
Qty:4

## Connections I

# A

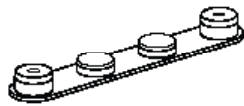

MOD-180D-CON / MOD-PC

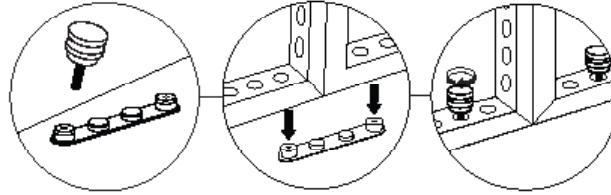

# B

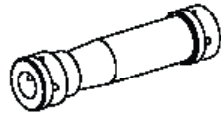

MOD-CLA-CON

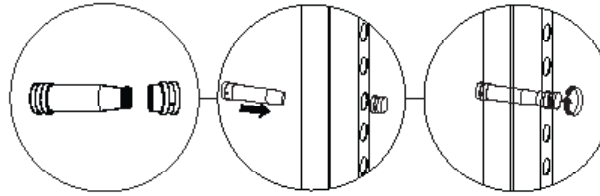

# C



MOD-90D-CON + MOD-PC

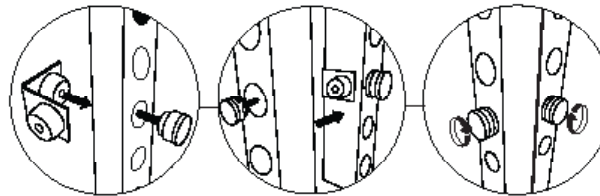

## Connections II

# D

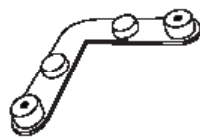

MOD-SM90D-CON / MOD-PC

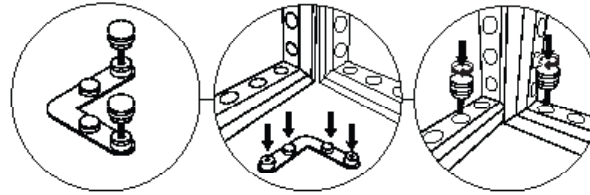

# E

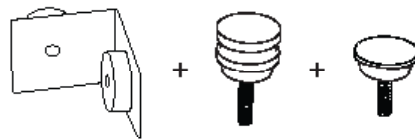

MOD-90D-CON / MOD-PC / MOD-PCDOOR  
\*Same as (C) but MOD-PCDOOR will be inside of door jam

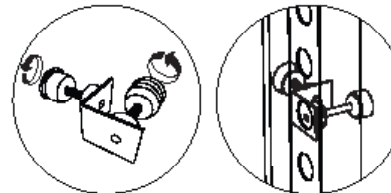

# F

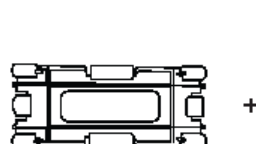

MOD-CC / MOD-CP-3100 / MOD-CP-774

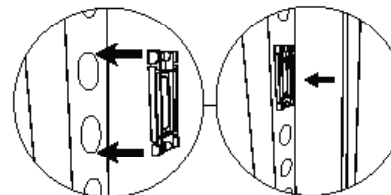

### Connections III

# G

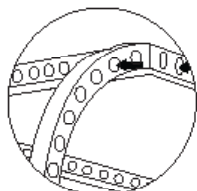
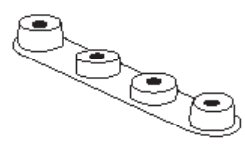

**OUTSIDE**

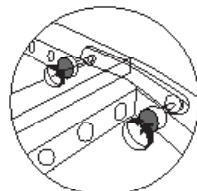

**INSIDE**

# H

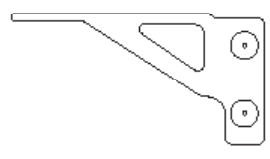

**MOD-SHELF-KIT-INS**

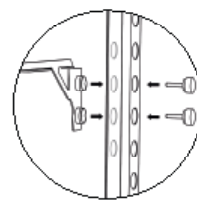

**INSIDE OF FRAME**

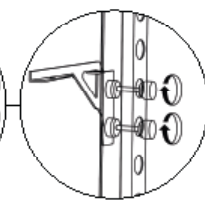

# 1

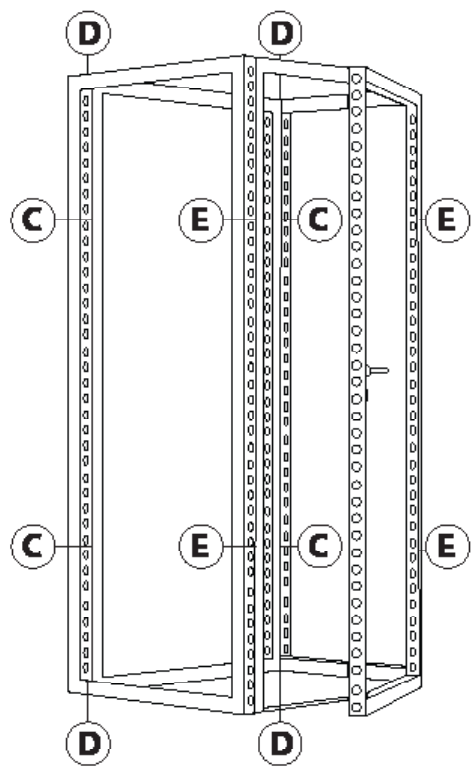



On frame On graphic

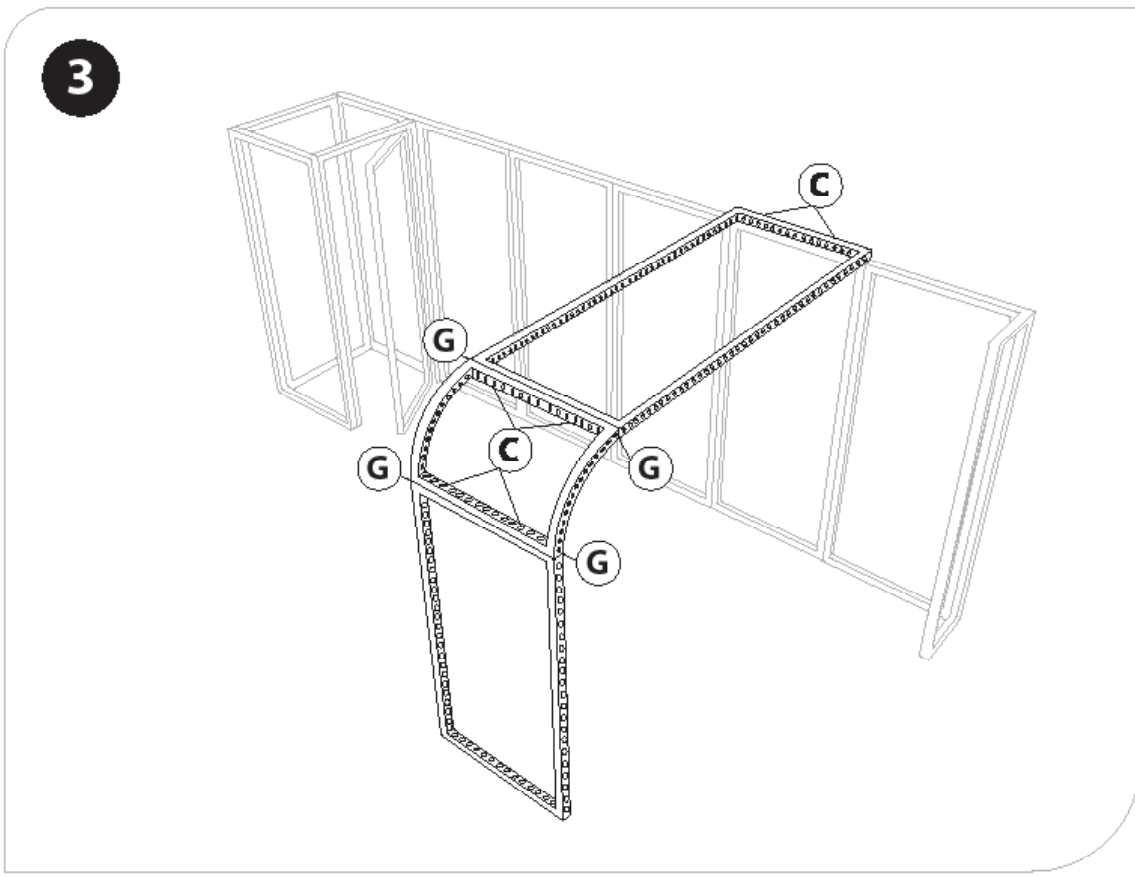
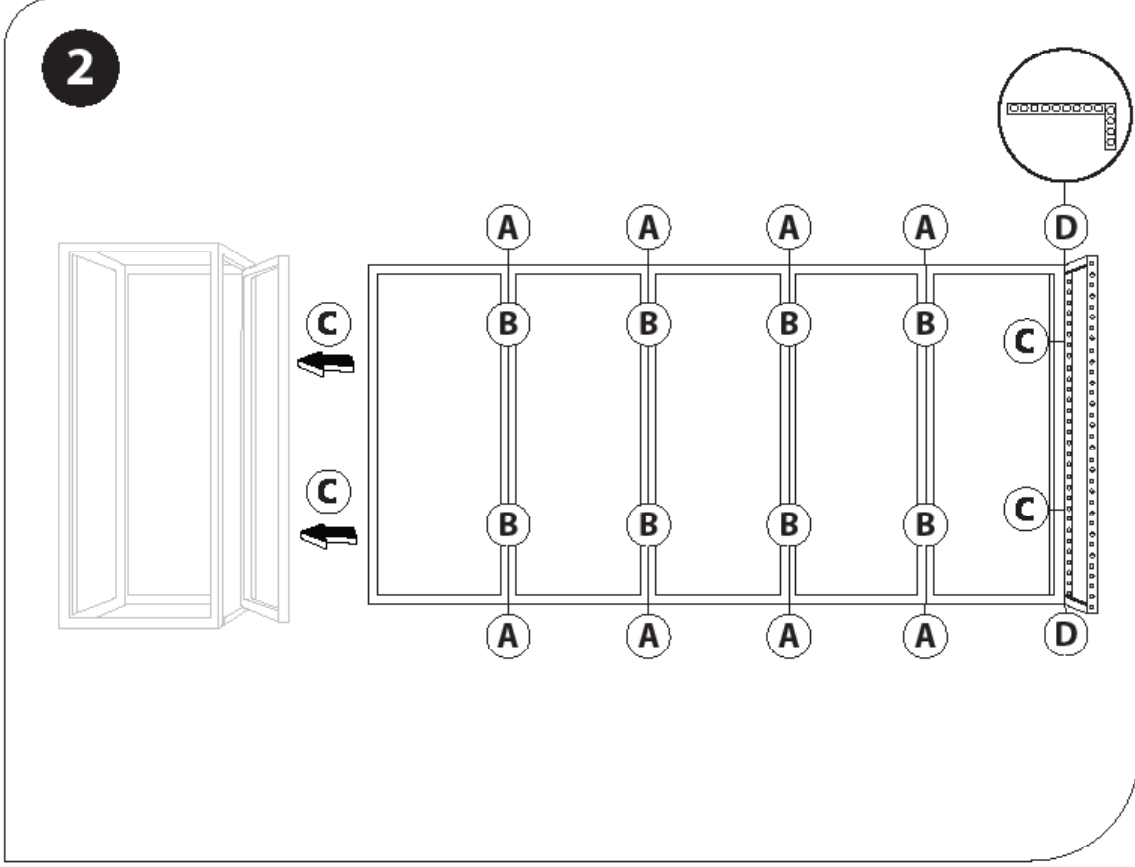

4

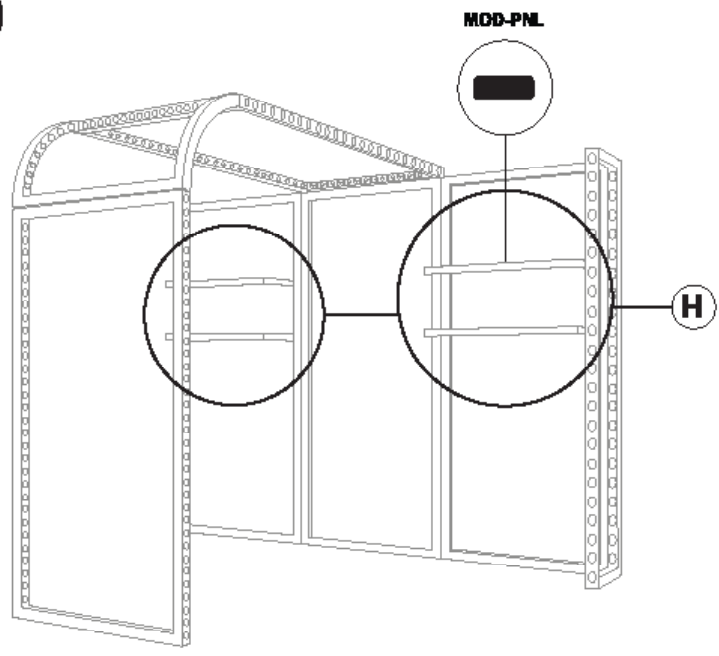

Slide panels onto shelf brackets. NO DRILLING REQUIRED.

### Cover Profiles

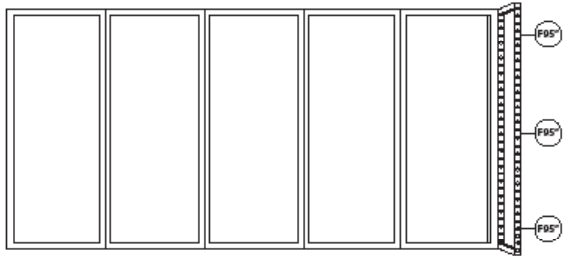
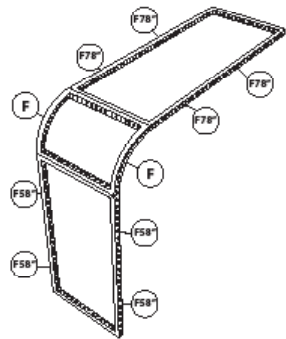
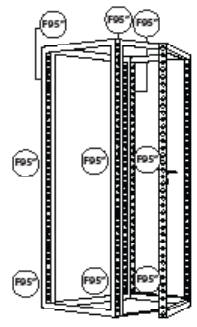

Snap in clip connectors at each designated point and then reference the measurement and install the cover profile.  
\*Overhead view - clip connectors/cover profiles to back side of configuration.

## Graphic Install



Place graphic over the front of the frame.



Begin inserting SEG beading at each corner.

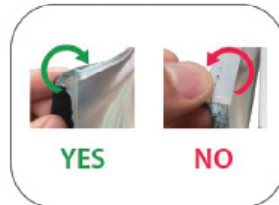

Insert the silicone beading with the fabric folded over. The silicone beading should not be exposed.



Using your fingers, push both fabric and silicone beading completely into the extrusions channel.

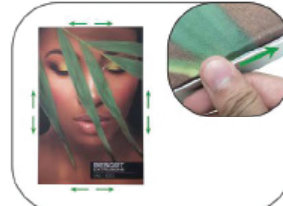

Continue to push in the remaining silicone beading on each side.

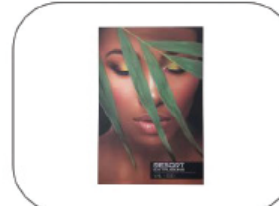

Check the perimeter of the frame for any excess beading that hasn't been pushed in. Graphic should be taut.