

Formulate Tower - 03

TOWER-03

When you are looking for a way to draw attention and captivate your audience at a tradeshow, special event, or in a permanent environment, these Formulate® tension fabric architectural structures are designed to impress. Mix and match the Formulate line of towers to add architecture and drama to any event or interior space. Cylinder, Rectangular and Shield-shaped towers come in 12', 10' and 8' heights and 3' square / diameters at the tops and bottoms.

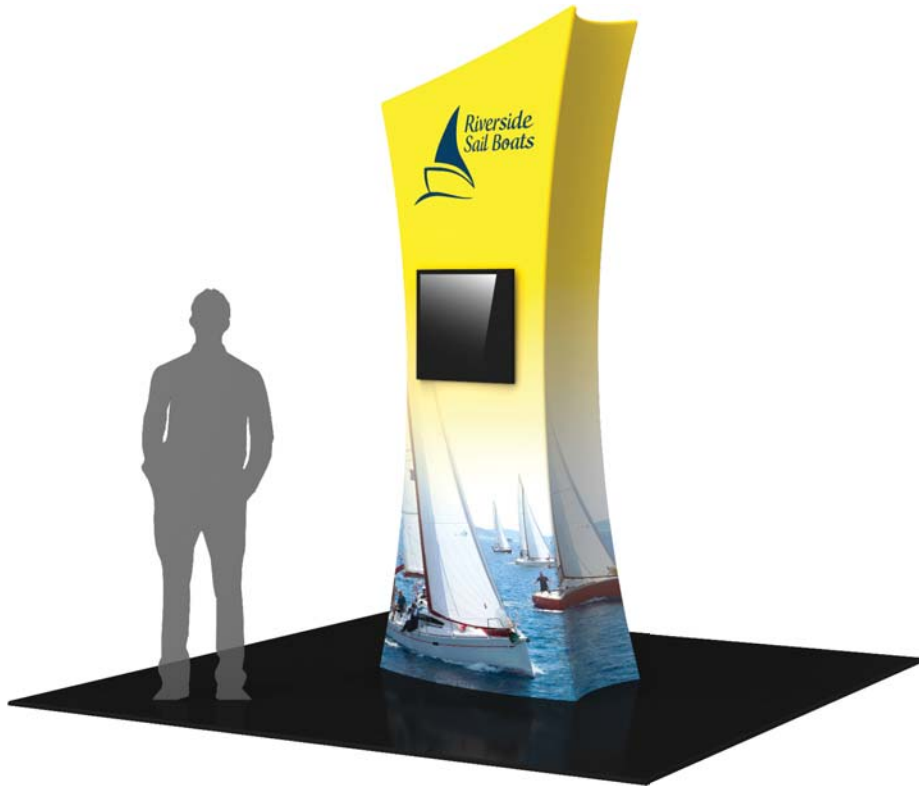

features and benefits:

- Premium aluminum tube frames with spigot and snap button assembly
- Easy to store and ship
- Quick to set up
- Lifetime limited hardware warranty against manufacturer defects
- One zipper pillowcase fabric graphic
- Kit includes:
 - (2) medium monitor mounts, can hold 32-55" monitor/ max weight 15 lbs

dimensions:

Hardware	Graphic
Assembled unit: 60.15" w x 120" h x 36" d 1528mm(w) x 3048mm(h) x 914mm(d) Approximate weight with cases: 119 lbs / 54gs	Refer to related graphic template for more information. Visit: www.exhibitors-handbook.com/graphic-templates
Shipping	
Packing case(s): 1 OCE Case 1 OCH Case Shipping dimensions: OCE: Expandable case length (l) may vary 40"-66" l x 18" w x 18" h 1016mm-1676mm(l) x 457mm(h) x 457mm(d) OCH: 50" l x 29" w x 12" h 1270mm(l) x 737mm(w) x 305mm(h) Approximate total shipping weight (includes cases & graphics): 137 lbs / 62kgs	<h2>additional information:</h2> <p>Graphic material: dye-sublimation zipper pillowcase fabric</p> <p>*Monitors not included</p> <p>When included in a larger kit, a different packaging solution will be listed to accommodate all contents of the kit. Individual packaging no longer provided.</p>

We are continually improving and modifying our product range and reserve the right to vary the specifications without prior notice. All dimensions and weights quoted are approximate and we accept no responsibility for variance. E&OE. See Graphic Templates for graphic bleed specifications.

Included In Your Kit

Tools, Components,
& Connectors



ALLEN KEY SET x1



ES30 x40



TUBE-M-MB x2

Graphics



TOWER-03-G x1

Included In Your Kit

Tubes



TOWER-02-T1 x2



TOWER-02-T2 x2



TOWER-02-T3 x2



TOWER-02-T4 x2



TOWER-02-T5 x2



TOWER-02-T6 x4



TOWER-02-T7 x2



TOWER-02-T8 x2



TOWER-02-T9 x1



TOWER-02-T10 x2



TOWER-02-T11 x1



TOWER-02-T14 x4



TOWER-02-T15 x1



TOWER-02-T16 x1

Exploded View

TOWER-03

FRAME A

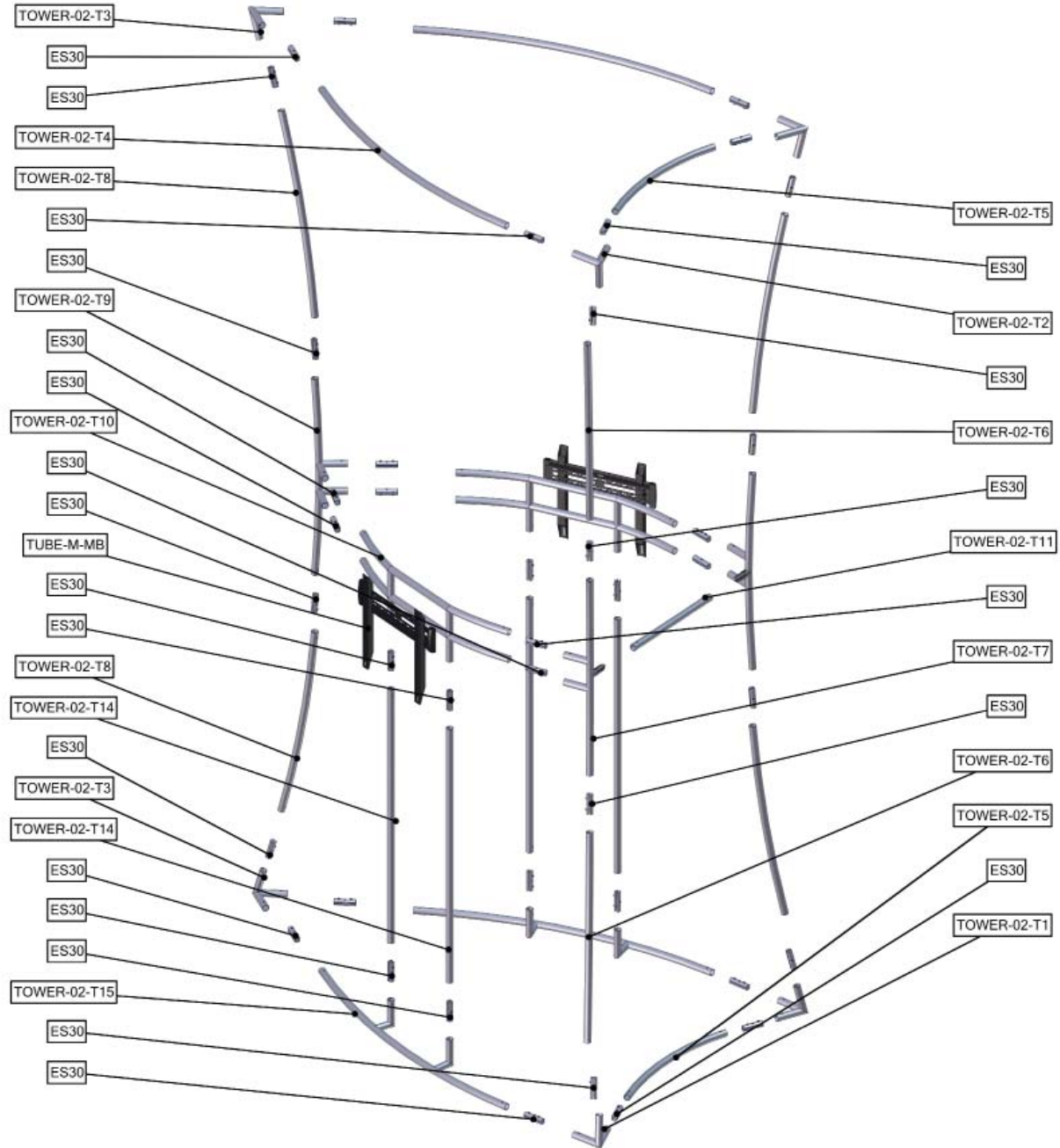

Labeling Diagram

TOWER-03

FRAME A

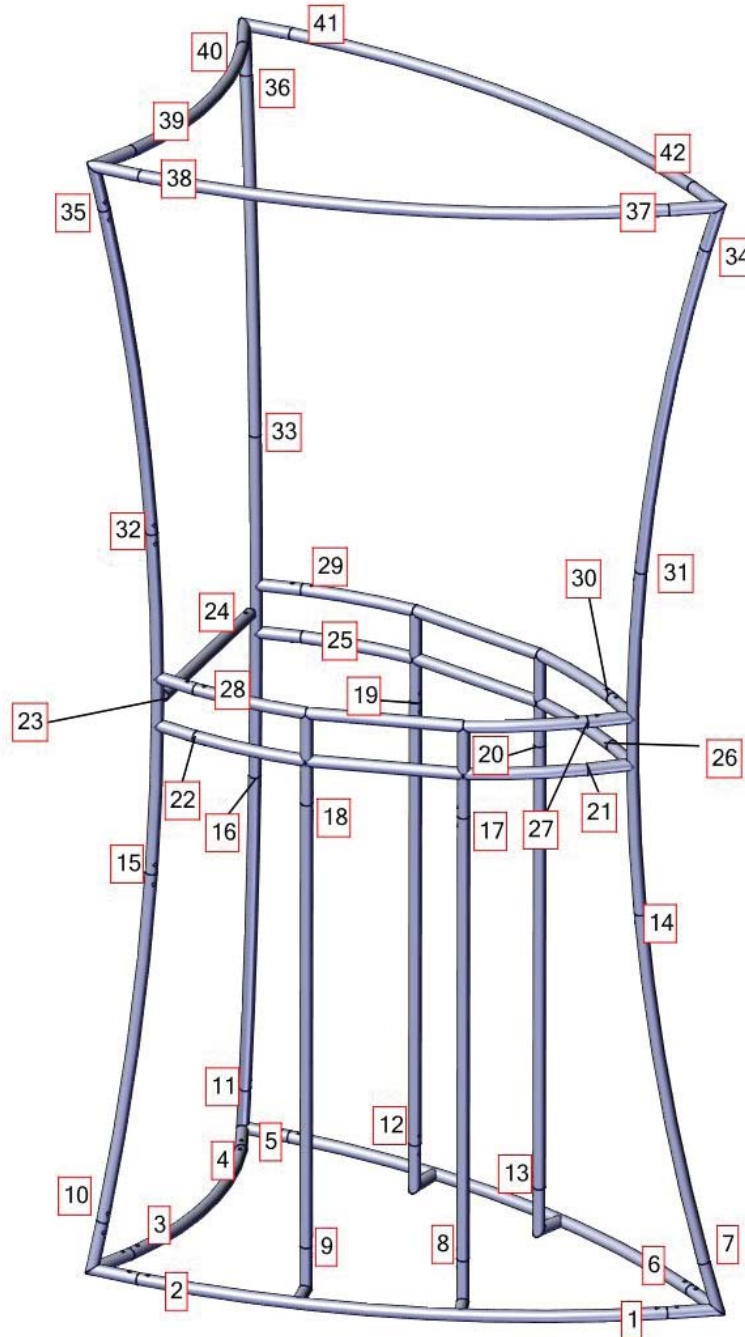

Connection Methods

Formulate® structures use a number of different yet simple connection methods. Your kit will include one or more of the connection methods shown below. Steps within the Kit Assembly will reference a specific method for each connection point.

Connection Method 1: ES30 / ES50 / ES75

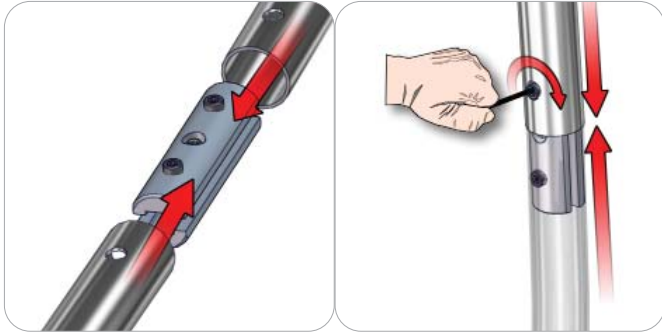

Compress the unlocked connector and slide one tube onto each end. Lock both screws carefully using your allen key tool. Be sure to lock securely, but do not overtighten.

Connection Method 2: Snap Buttons & Swage

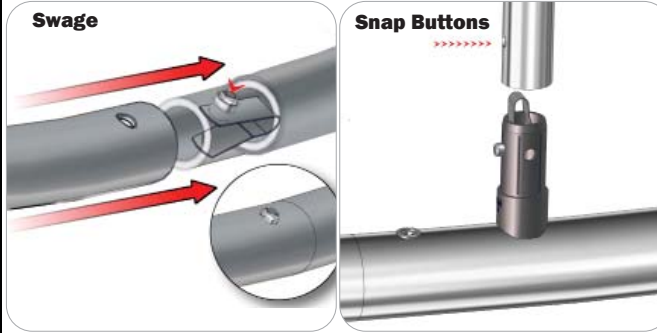

Locate the snap button on the connector or swage tube. Locate the hole on the corresponding tube. Press the snap button with your thumb and slide the tube and connector together so that the snap button snaps fully into the lock hole. To disassemble, press the snap button and pull apart.

Connection Method 3: ES30-90B / ES30-I / ES30-C

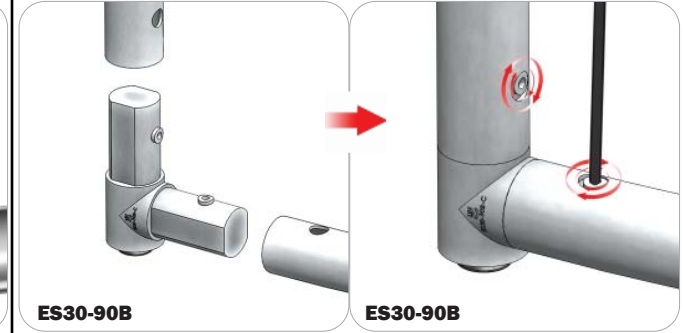

Compress one unlocked end of the connector and slide it through one tube end. Compress the other end of the connector and slide the second tube on. Lock both screws carefully using your allen key tool. Be sure to lock securely, but do not overtighten.

Connection Method 4: Tube Clamps

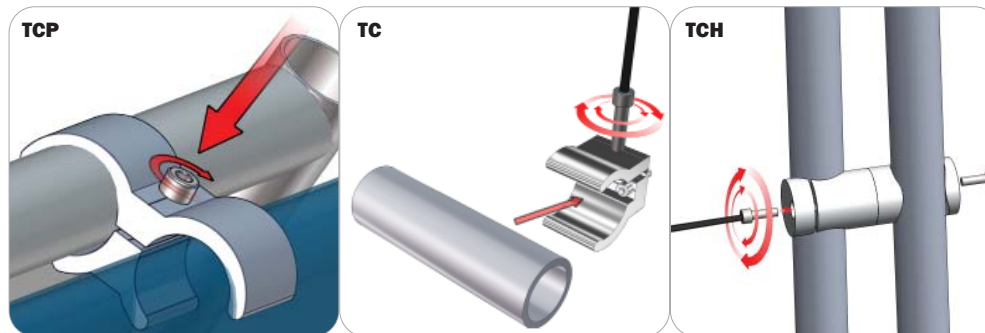

Be sure to fully assemble all frames before using clamps. With the clamp unlocked, place one tube of the first frame into the mouth of the clamp. Place the second tube (if applicable) into the second mouth of the clamp. With both frame's tubes in the clamp, be sure to lock securely, but do not overtighten.

Kit Assembly

Step by Step

Step 1.

Gather the components necessary for assembling Frame A. Assemble in the order the Labeling Diagram instructs.

Refer to Connection Methods 1 and 2 for additional information.



Step 2.

With the frame laying flat on the floor, locate your pillowcase graphic. With the pillowcase unzipped, encase the frames and zip along the side and bottom.

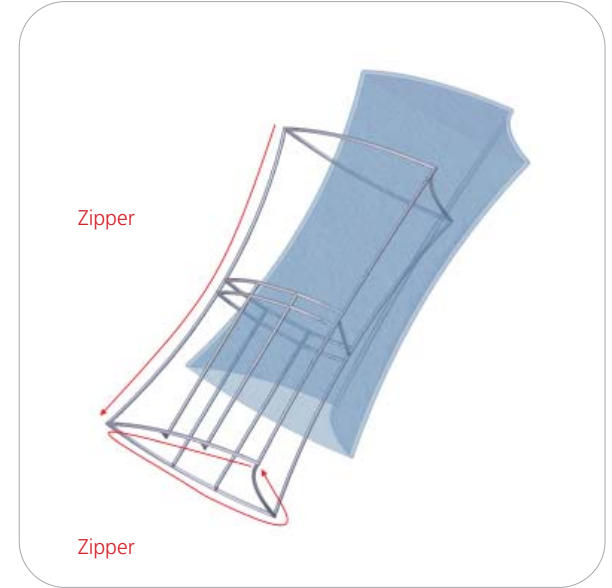

Step 3.

Attach your monitor mounts through the graphic to the top center tubes of both sides of the frame.

Refer to Connection Method 4 and Monitor Bracket Instruction pages for additional information.



Monitor Bracket Instructions

Tube Applications



TUBE-SM-MB

Sizes: 17" - 37"

Max weight varies per application



TUBE-M-MB

Sizes: 32" - 55"

Max weight varies per application



TUBE-LG-MB

Sizes: 40" - 65"

Max weight varies per application

Included hardware:

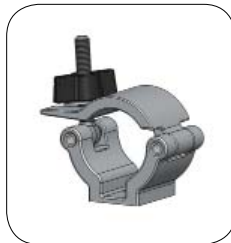

ACC60 x2



TCH-30 x2

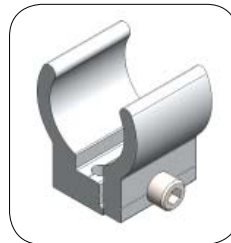

TC-30MM-SILVER x2



BOLT-1 x4



Flange Wingnut x4

TUBE CONNECTION

ACC60 Clamp Connection

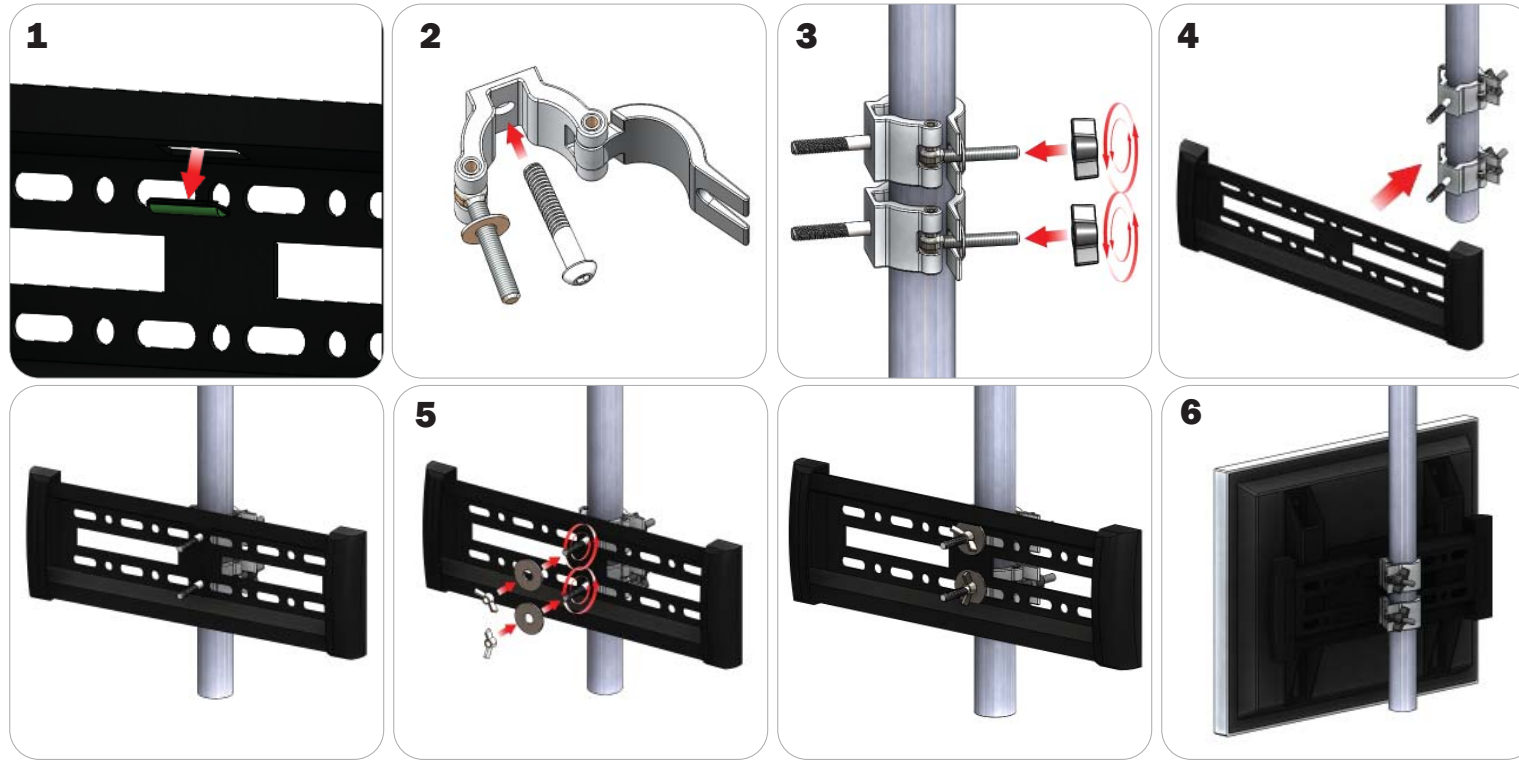

Locate all components needed to assemble the monitor mount with the ACC60 tube method. You will need (1) monitor bracket, (2) ACC60 clamps, (2) washers, and (2) wingnuts. **Step 1:** Apply pressure to the rear side of the leveling gauge clipped into the monitor mount to remove it. **Step 2:** Push the provided bolt through the hole in the ACC60 and place the ACC60 in the desired location. **Step 3:** Tighten the clamp to the tube using the plastic wingnut. **Step 4:** Set your monitor bracket onto the protruding bolts using the of the ACC60 using the center holes on the monitor bracket., adjust ACC60 position if necessary. **Step 5:** Lock your monitor bracket to the ACC60s by placing your washers and locking with provided wingnuts. **Step 6:** Reference the included manufacturer monitor mount instructions for fastening your monitor to the bracket.

TCH Clamp Connection (Tablet Stands)

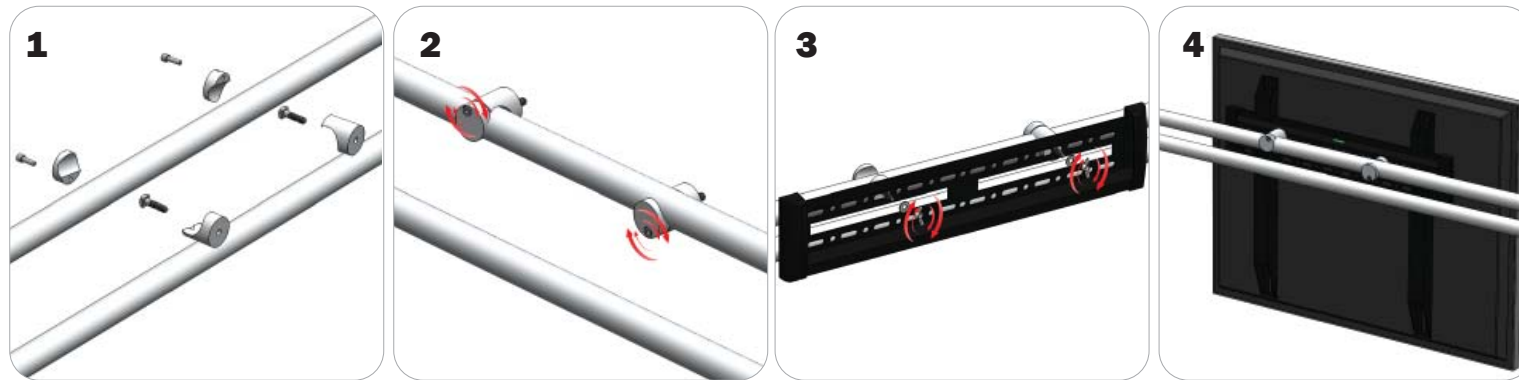

Locate all components needed to assemble the monitor mount with the TCH tube method. You will need (1) monitor bracket, (2) TCH clamps, (2) bolts, (2) washers, and (2) wingnuts. Determine your desired monitor location. **Step 1:** Fit the provided bolts through the TCH clamps then reassemble the clamp. **Step 2:** Lock the clamp onto the tube with the allen head screws on the clamp. **Step 3:** Align your monitor bracket so that the left and right holes slide onto the bolts behind them. Use your washers and wingnuts to lock your monitor bracket in place. **Step 4:** Reference the included manufacturer monitor mount instructions for fastening your monitor to the bracket.

TUBE CONNECTION

TC-30 Clamp Connection

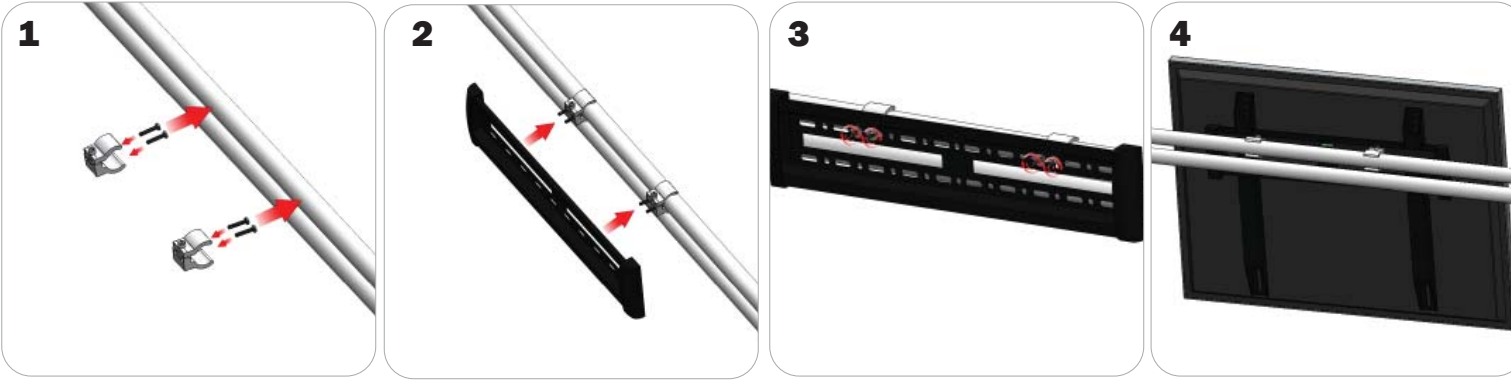

Locate all components needed to assemble the monitor mount with the TC-30 tube clamp method. You will need (1) monitor bracket, (2) TC-30-SILVER clamps, (4) BOLT-1 screws, and (4) flange wingnuts. **Step 1:** Insert the pan-head screws through the holes of your TC-30 clamps. Attach the TC-30 clamps to the tubes but do not tighten. **Step 2:** Set your monitor bracket onto the protruding pan-head screws on your clamps using the holes in the monitor bracket. **Step 3:** Apply your flange wingnuts to the front of your monitor bracket to lock it to the clamps. Lock your clamps securely into place. **Step 4:** Reference the included manufacturer monitor mount instructions for fastening your monitor to the bracket.