

Formulate 10' Shield Tower

SHD-TOWER-02

When you are looking for a way to draw attention and captivate your audience at a tradeshow, special event, or in a permanent environment, these Formulate™ tension fabric architectural structures are designed to impress. Mix and match the Formulate line of towers to add architecture and drama to any event or interior space. Cylinder, Rectangular and Shield-shaped towers come in 12', 10' and 8' heights and 3' square/diameters at the tops and bottoms.

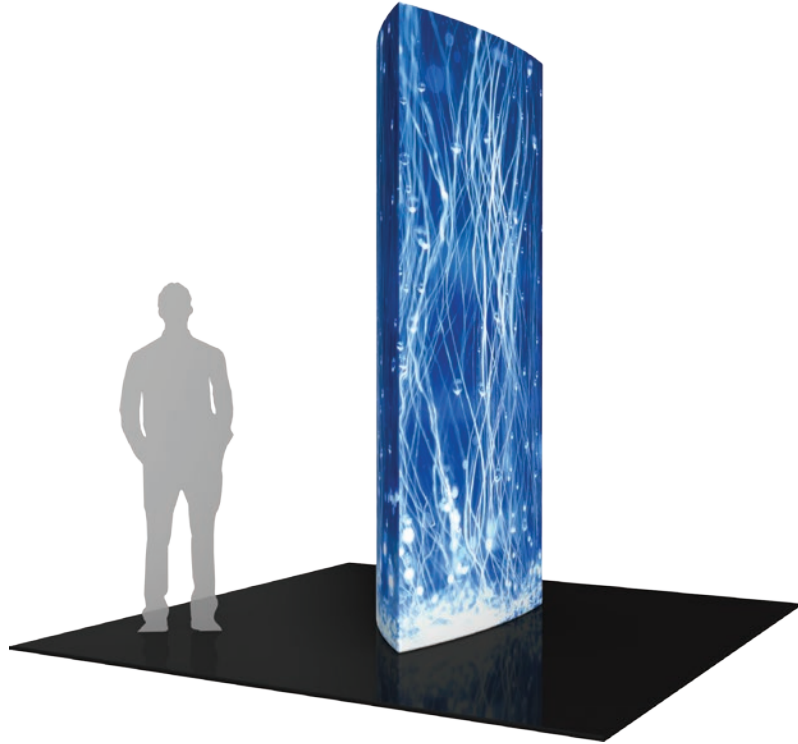

features and benefits:

- Premium aluminum tube frames with snap button assembly
- Easy to store and ship
- Quick to set up
- One zipper pillowcase fabric graphic
- Lifetime limited hardware warranty against manufacturer defects

dimensions:

Hardware

Assembled unit:
120"h x 59.5"d x 36"w
3048mm(h) x 1509mm(d) x 912mm(w)

Approximate weight with cases:
100 lbs / 45.36kgs

Shipping

Packing case(s):
1 OCE Case
1 OCH Case

Shipping dimensions:
OCE: Expandable case length (l) may vary
40"-66"l x 18"w x 18"h
1016mm-1676mm(l) x 457mm(h) x 457mm(d)

OCH:
50"l x 29"h x 12"d
1270mm(l) x 737mm(h) x 305mm(d)

Approximate total shipping weight
(includes cases & graphics):
125 lbs / 56.87kgs

Graphic

Refer to related graphic template for more information.

Visit:
www.exhibitors-handbook.com/graphic-templates

additional information:

Graphic material:
dye-sublimation zipper pillowcase fabric

We are continually improving and modifying our product range and reserve the right to vary the specifications without prior notice. All dimensions and weights quoted are approximate and we accept no responsibility for variance. E&OE. See Graphic Templates for graphic bleed specifications.

Included In Your Kit

Tools, Components,
& Connectors



TC-30-A-110° x4



TC-30-A-60° x2



TC-30-T x1

Tubes



SHDTOWER-01-T1 x4



SHDTOWER-01-T2 x2

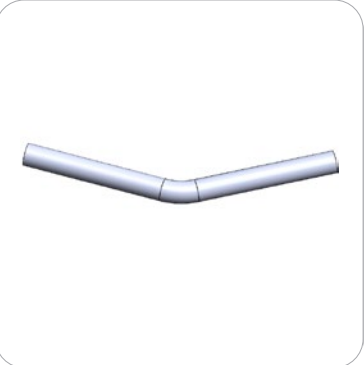

SHDTOWER-01-T3 x2



SHDTOWER-01-T4 x1



SHDTOWER-02-T6 x3



SHDTOWER-02-T7 x3

Graphics

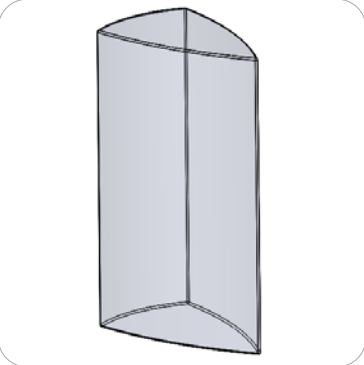

SHDTOWER-02-G x1

Exploded View

SHDTOWER-02

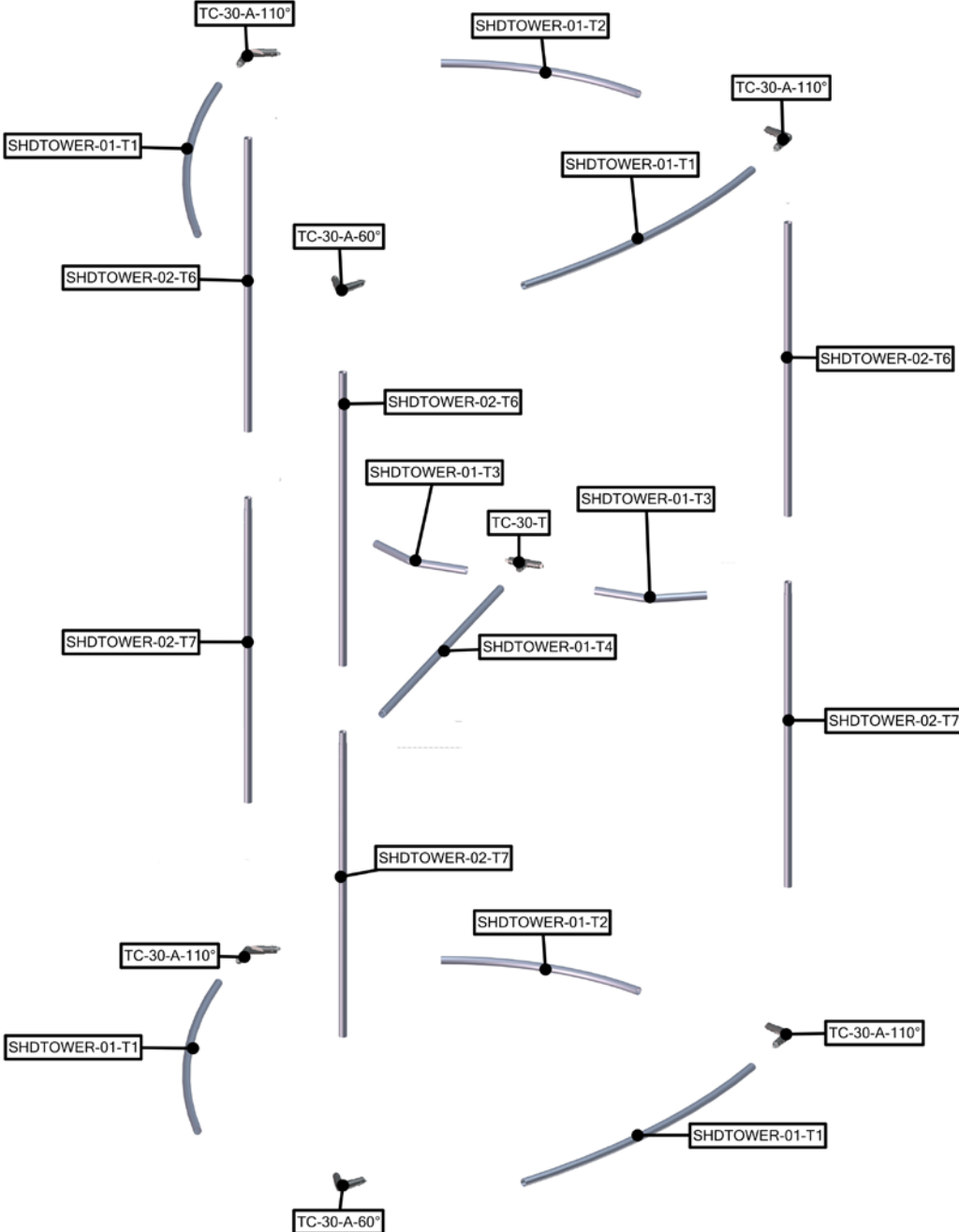

Labeling Diagram

SHDTOWER-02

OVERVIEW

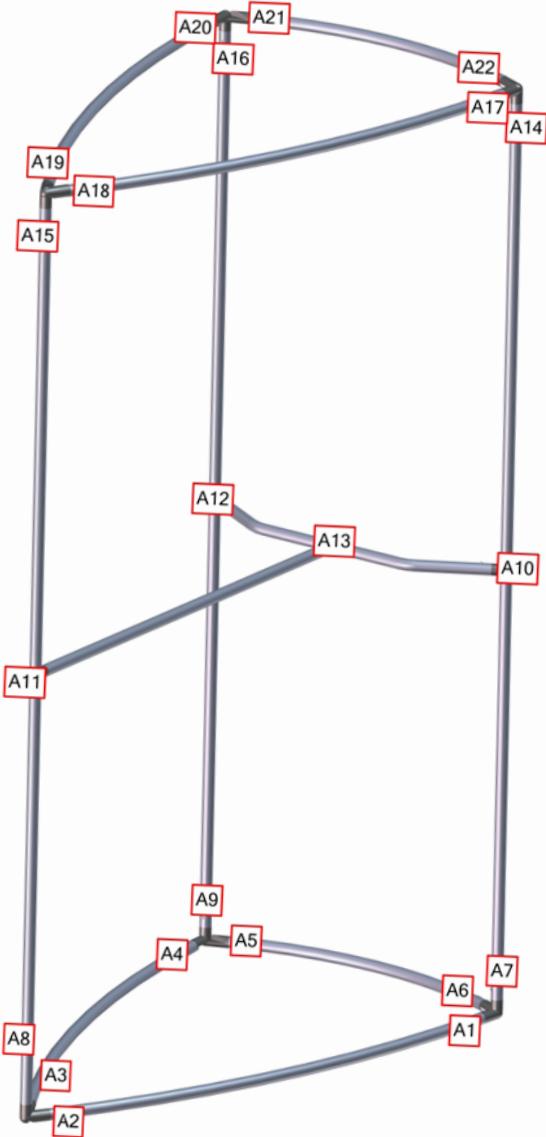
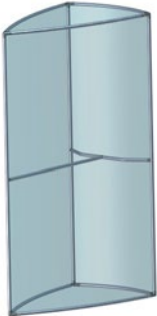
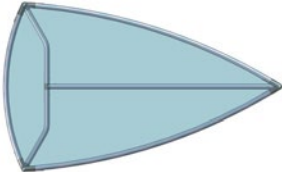

Connection Methods

Formulate® structures use a number of different yet simple connection methods. Your kit will include one or more of the connection methods shown below. Steps within the Kit Assembly will reference a specific method for each connection point.

Connection Method 1: ES30 / ES50 / ES75

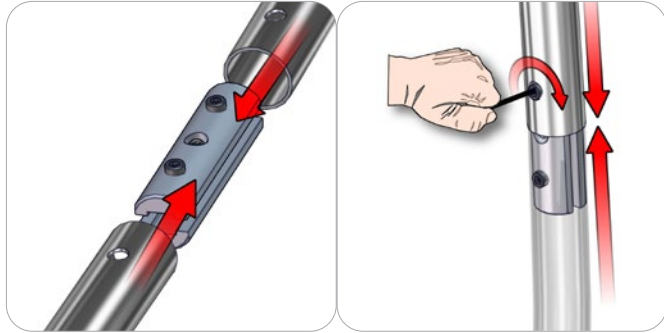

Compress the unlocked connector and slide one tube onto each end. Lock both screws carefully using your allen key tool. Be sure to lock securely, but do not overtighten.

Connection Method 2: Snap Buttons & Swage

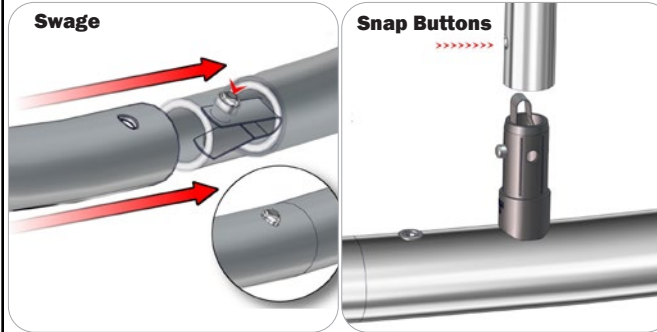

Locate the snap button on the connector or swage tube. Locate the hole on the corresponding tube. Press the snap button with your thumb and slide the tube and connector together so that the snap button snaps fully into the lock hole. To disassemble, press the snap button and pull apart.

Connection Method 3: ES30-90B / ES30-I / ES30-C

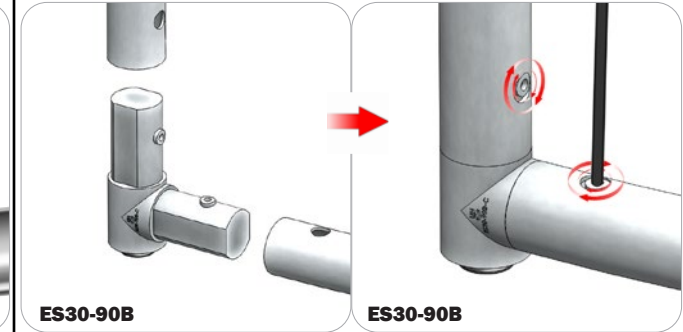

Compress one unlocked end of the connector and slide it through one tube end. Compress the other end of the connector and slide the second tube on. Lock both screws carefully using your allen key tool. Be sure to lock securely, but do not overtighten.

Connection Method 4: Tube Clamps

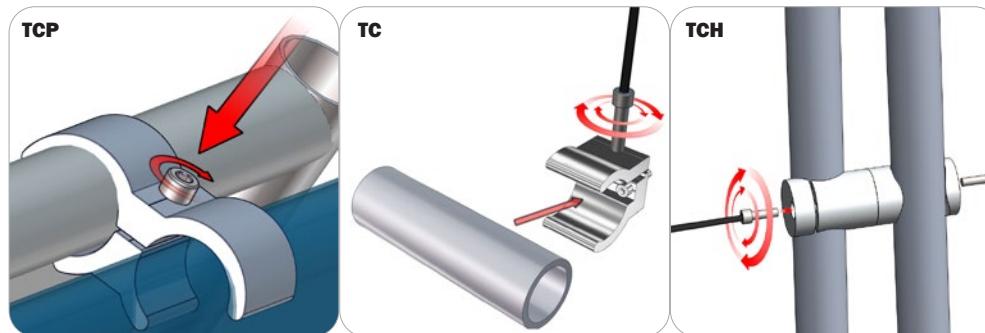

Be sure to fully assemble all frames before using clamps. With the clamp unlocked, place one tube of the first frame into the mouth of the clamp. Place the second tube (if applicable) into the second mouth of the clamp. With both frame's tubes in the clamp, be sure to lock securely, but do not overtighten.

Kit Assembly

Step by Step

Step 1.

Gather the components necessary for assembling the frames. Assemble in the order as the Labeling Diagram instructs.

Refer to Connection Method 2 for additional information.

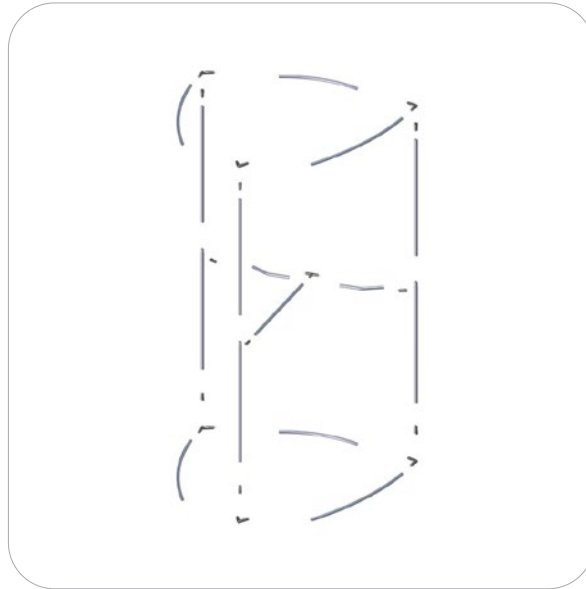

Step 2.

With frame laying flat on the floor, cover the frame from the top to the bottom. Zip to enclose

