

EZ EXTEND CIRCLE 7 DISPLAY

EZ EXTEND DISPLAYS

PRODUCT CODE: EZ-EC84X87



PRODUCT DESCRIPTION

Introducing Round EZ Extend Displays! Score big attention with this simple hoop frame covered in stunning custom graphics. Signature lightweight aluminum snap tubes connect together. Single- or double-sided fabric pillowcase graphic easily zips taut. Steel base provides stability. Available in 3', 5' and 7' diameters.

DISPLAY DIMENSIONS	84"W x 87"H x 10"D
GRAPHIC SIZE	84.5"W x 84.5"H

GRAPHIC MATERIAL

Dye-Sublimated Stretch Fabric

GRAPHIC FINISHING

Pillowcase finishing and zipper sewn across top

DISPLAY CONSTRUCTION

Aluminum frame and steel base

SHIPPING WEIGHTS & DIMENSIONS

Shipping Weight	25 lbs (stand only) 26 lbs (frame and graphic)
Shipping Dimensions	48.5"L x 13"W x 5"H

LARGE QUANTITY FREIGHT

Freight Shipping	36 boxes per 48"L x 40"W x 70"H skid
Freight Weight	900 lbs (frame only) 936 lbs (frame & graphic)

GRAPHIC TURN AROUND TIME

2 business days after proof approval

AVAILABLE ACCESSORIES

EZ Tube LED Lights (Black or Silver)

AVAILABILITY	CA and PA
--------------	-----------

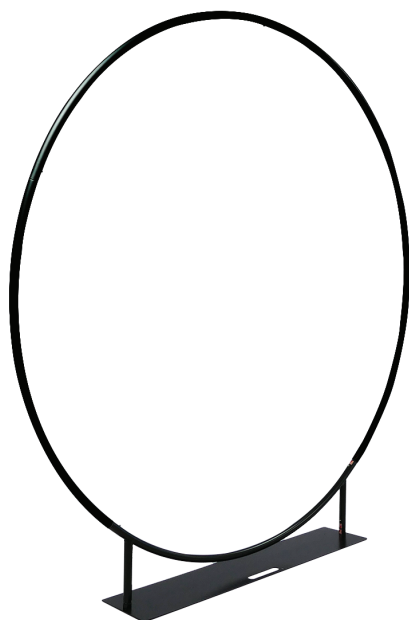

*EZ Tube LED Light
(Black and Silver available)



Welded frame design
(bottom support)

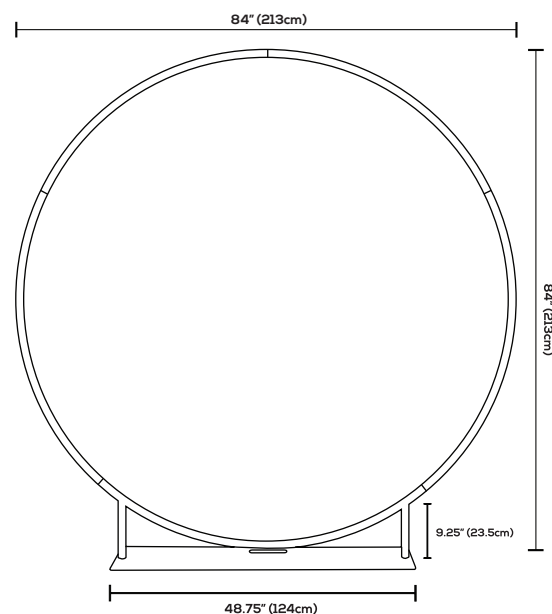

EZ EXTEND CIRCLE 7 DISPLAY

EZ EXTEND DISPLAYS

PRODUCT CODE: EZ-EC84X87

PARTS LIST

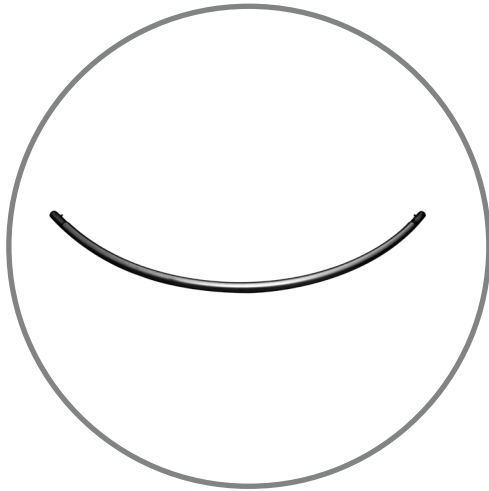

Qty.1 Male/Male Tube

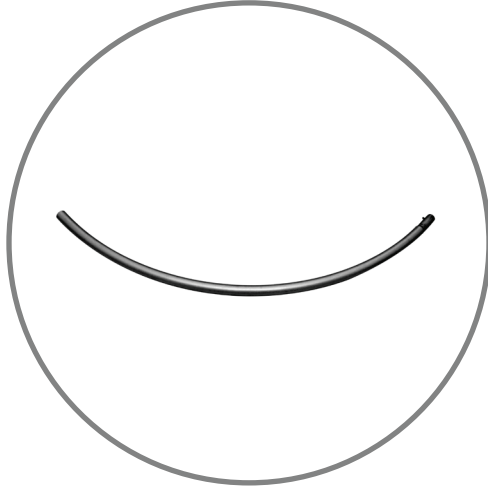

Qty.3 Male/Female Tube

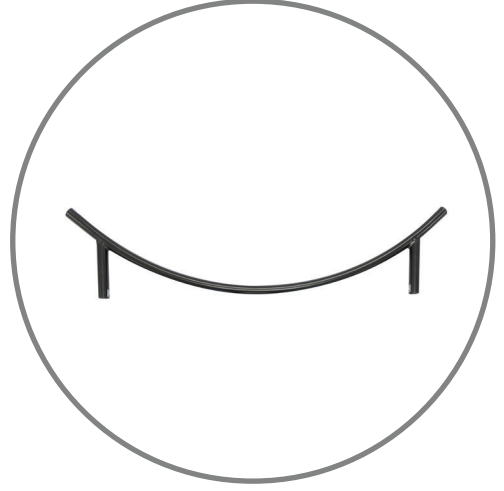

Qty.1 Bottom Support Tube

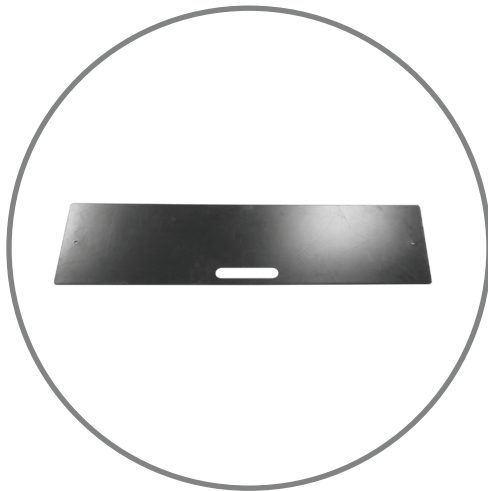

Qty.1 Base



Qty.2 Base Legs

ROUND EZ EXTEND DISPLAY INSTRUCTIONS

The following instructions are compatible with all shapes and sizes of Round EZ Extend frames.

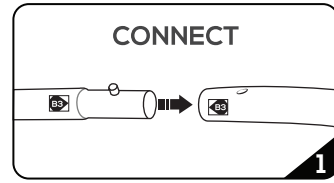
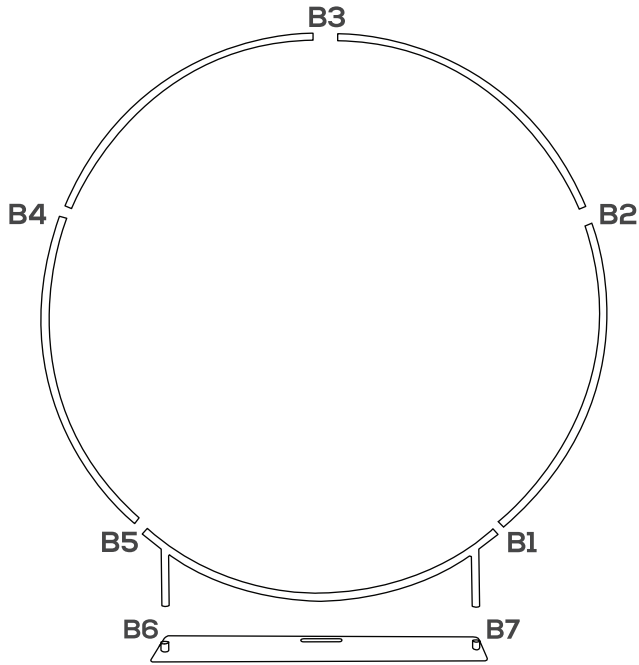

Connect numbered tubes together.

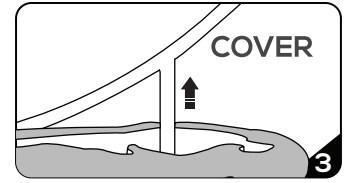

Pull graphic up from bottom of frame and close zippers.

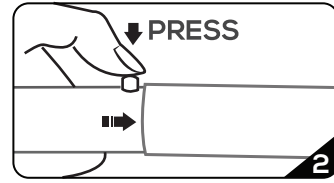

Push button down and insert tube.

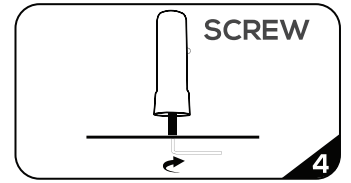

Screw legs into base.

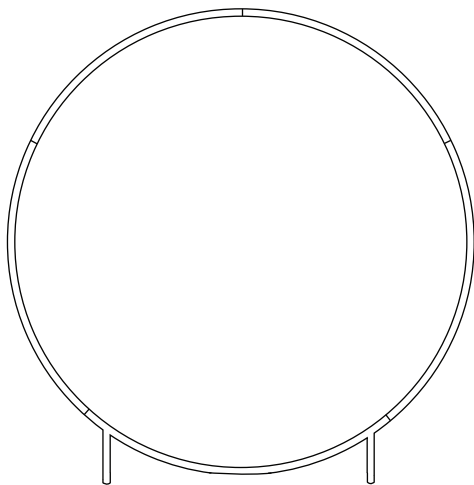

Set up frame, snap tubes together.

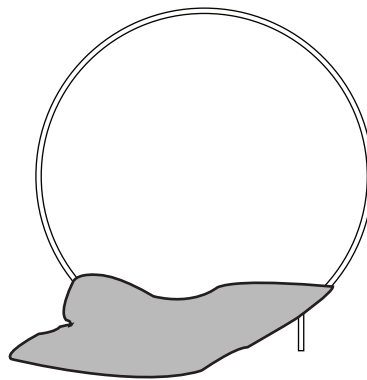

Drape bottom of graphic over the bottom of the frame. Thread the "legs" through and insert them into the base. Pull graphic halfway up the frame.

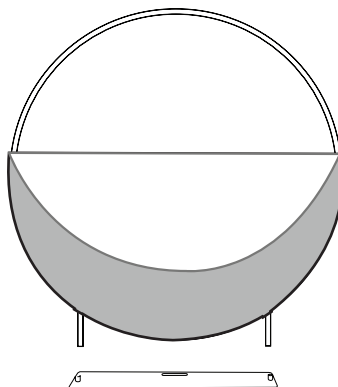

Close zipper over the top of the frame.